



panoramic<sup>®</sup>

h-line



“

Each panel has a function, with infinite possibilities for personalization

”

panoramic®  
h-line

# 3 Pre-assembled modules

Modular exhibits



# 4 Concept

Modular exhibits



- Panoramic h-line is a trade show display system which allows you to easily create a custom exhibit using pre-assembled modules.
- With its full surface area completely dedicated to the graphic image, Panoramic h-line creates an unparalleled visual impact while also providing a full assortment of useful functionalities.
- Panoramic h-line is a perfect solution for those that would like an exhibit that is both modular and flexible for purchase or rental.

# 5 Benefits

## Five reasons to choose panoramic h-line

- Showcase your image  
Put the graphic image front and center! No visible aluminum profile means your message is even more effective and your exhibit carries **a true mark of quality.**
- Endless modularity  
All module types can be connected to one another - no restrictions! **Rest assured that you can use your exhibit in every space,** even those you have yet to consider. Panoramic h-line is a completely scalable solution that grows along with your company.
- Focus on the essentials!  
Each module has been designed to provide its own unique functionality (communicate, display, design, spread your message, store, and welcome customers). **You can pre-fit certain modules by adding optional kits for even more functionality.**
- Be creative!  
Distinguish your company by creating your own custom graphic or use our database of colors and patterns specifically chosen for Panoramic h-line. **Put a part of yourself in your exhibit!**
- CLEVER & SIMPLE  
Panoramic h-line requires **zero technical expertise** and is set-up without the use of tools. Set-up up the exhibit yourself, or with our assistance. Standard modules do not exceed a weight of 19 lbs. Set-up for a 20' x 10' exhibit takes less than 1 hour for 1 person.



# 6 Concept

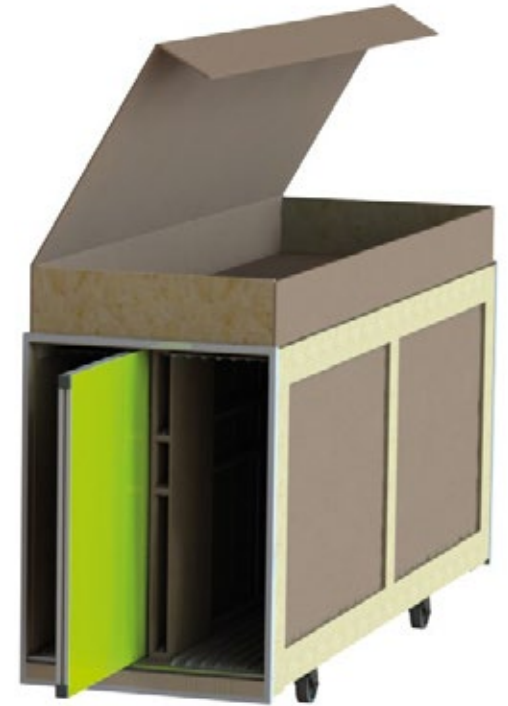
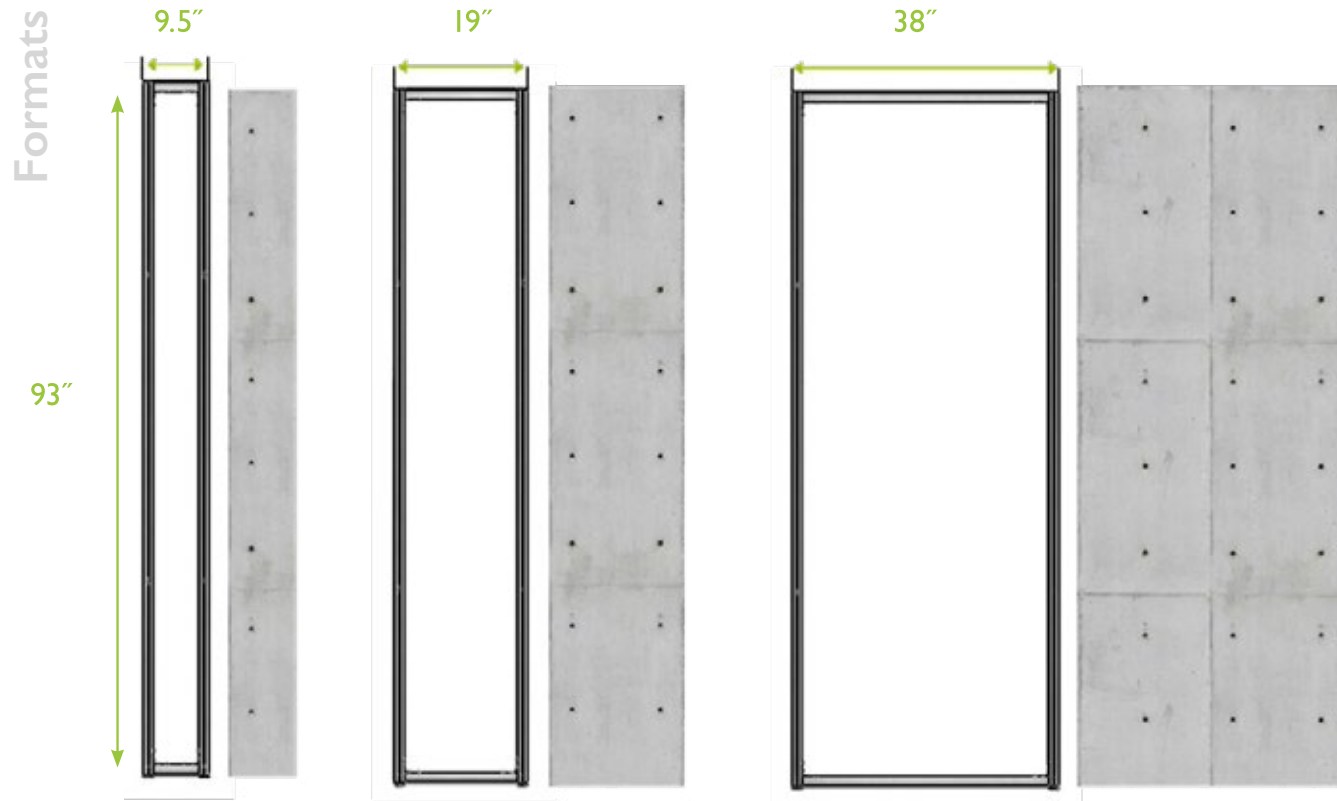

3 modules sizes:  
9.5", 19" and 38"

Every panel is delivered with pre-installed graphics, just connect them!

# 7

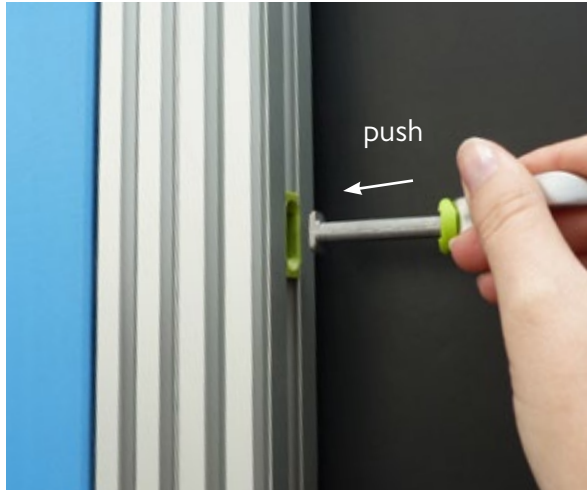

All module types can be connected to one another



Result: no visible aluminum profile!

# 8 Graphics

- Dye-sublimated fabric graphics
- Features a silicone edge (SEG) attachment system, in which silicone is sewn into the edge of the graphic and is then inserted into the groove of the Panoramic profile.
- Extremely precise graphic dimensions ensure perfect graphic tension upon installation
- The right fabric for each use: opaque Panopac fabric for maximum visual impact and optimal color rendering, light-diffusing fabric for lightboxes and backlit frames
- Easy to transport and ship



Grommets provide optimal and durable cable management



# 9 Process

Design and quote your exhibit in 4 easy steps and 30 minutes or less!

3D Studio

Welcome to the panoramic<sup>®</sup>  
h-line

## Creating an exhibit has never been so simple

**STEP 01**  **EXHIBIT SIZE**  
To start, choose the size and type of booth that you have rented: length, width, and number of open sides.

**MODULE CHOICE**  
At a show, every sq ft counts!  
Welcome, display, store, spread your message...  
Choose and position modules according to the functionalities you need.

**STEP 02** 

**STEP 03**  **GRAPHIC WRAPPING**  
The most important thing at a show is to create a strong impact.  
Upload your own creations or be inspired by our selection of colors, patterns, and material effects. Creativity has no limits!

**FURNITURE/FINISHING**  
The success of your exhibit is in the details!  
To finish of the look, we offer a line of furniture, lighting options and additional finishing touches.

**STEP 04** 

 **RENDERING**

 **ESTIMATE**

**STEP 01**  **BOOTH SIZE**

I DEFINE MY SPACE



I input the characteristics of my space: length, width, number of open sides.

[WWW](#) [Let's go!](#)

**MODULE CHOICE**  **STEP 02**

I STRUCTURE MY SPACE



I build my booth by choosing the modules that meet my needs (close an angle, erect a wall, spread my message...)  
To save display production, welcome clients.  
All modules connect to one another.

Please visit available on the website.

[WWW](#) [Let's go!](#)

**STEP 03**  **GRAPHIC WRAPPING**

I SELECT MY GRAPHICS



I bring my vision: I choose between my own personalized graphics and a database of colors, patterns, textures, or material effects.  
Right click and then click on the preselected graphic to wrap each booth element.

Please visit available on the website.

[WWW](#) [Let's go!](#)

**FINISHINGS / FURNITURE**  **STEP 04**

I FINALIZE MY BOOTH



My booth is almost complete.  
We recommend adding finishing touches on each part of the booth and every fine detail.  
To add more functionalities to your booth: additional chairs and light are available to order.  
A database of accessories, furniture and plans for rendering purposes only, not for sale is available to you.

Please visit available on the website.

[WWW](#) [Let's go!](#) [Let's go!](#) [Let's go!](#)

# 10 Standard modules

Communicate



MODULES

HMS001  
Angled pole

---

HMS009  
Standard module 9.5"  
+ dye-sub graphic

---

HMS019  
Standard module 19"  
+ dye-sub graphic

---

HMS038  
Standard module 38"  
+ dye-sub graphic

---

GRAPHICS

Dye-sub graphic  
to wrap an  
exterior angle

---

Dimensions  
3.15" x 93"

Dye-sub graphic

---

Dimensions  
9.5" x 93"

Dye-sub graphic

---

Dimensions  
19" x 93"

Dye-sub graphic

---

Dimensions  
38" x 93"

# 11 Standard modules

Communicate



MODULES

HMSI01  
Half-height angled pole  
+ dye-sub graphic

---

HMSI09  
Half-height standard module 9.5"  
+ dye-sub graphic

---

HMSI19  
Half-height standard module 19"  
+ dye-sub graphic

---

HMSI38  
Half-height standard module 38"  
+ dye-sub graphic

---

GRAPHICS

Dye-sub graphic

---

Dimensions  
3.15" x 46.5"

Dye-sub graphic

---

Dimensions  
9.5" x 46.5"

Dye-sub graphic

---

Dimensions  
19" x 46.5"

Dye-sub graphic

---

Dimensions  
38" x 46.5"

# 12 Storage modules

Store

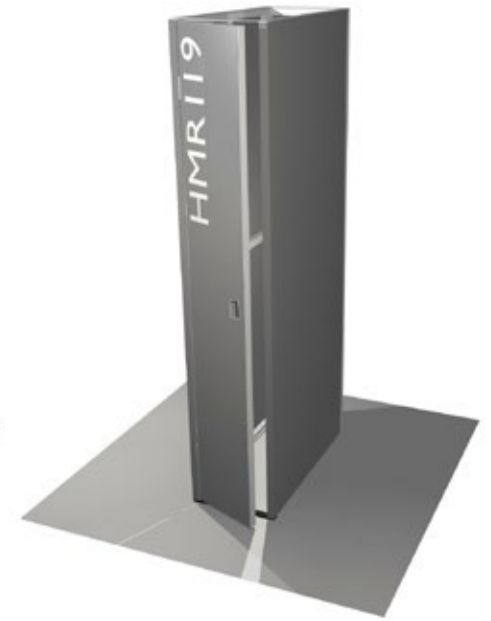

MODULES

HMR038  
Storage module 38"x38"  
+ dye-sub graphics

---

HMR138  
Storage module 38"x76"  
+ dye-sub graphics

---

HMR019  
Closet module 19"x19"  
+ kit of 2 shelves + dye-sub graphics

---

HMR119  
Closet module 19"x38"  
+ dye-sub graphics

---

GRAPHICS

6 dye-sub graphics

---

8 dye-sub graphics

---

6 dye-sub graphics

---

6 dye-sub graphics

---

Accessorize : add optional accessory kits to furnish your storage modules

# 13 Door modules

Store



More ergonomic and stylish door handle



MODULES

HMP019  
Door module 19"  
+ dye-sub graphics

---

HMP038  
Door module 38"  
+ dye-sub graphics

---

GRAPHICS

3 dye-sub graphics

---

3 dye-sub graphics

---

# 14 Standard lightbox module

Communicate



- New 1.57" thick, identical to non-backlit panels
- Perfect uniformity, without any light leakage
- Attaches to all panoramic h-line panels with one connector
- 2 outlets on each module: no more worrying about configurations!
- Shipped in h-line crate in a single slot with the graphic attached

# 15 Standard lightbox module - 1.57" thick

Communicate



Also available double-sided but with only one backlit side.

MODULES

HMS019-L2  
Standard Lightbox module 19"  
+ dye-sub graphic

---

HMS038-L2  
Standard Lightbox module 38"  
+ dye-sub graphic

---

GRAPHICS

Dye-sub graphic

---

Dimensions  
19" x 93"

Dye-sub graphic

---

Dimensions  
38" x 93"

# 16 Shelving modules

Display

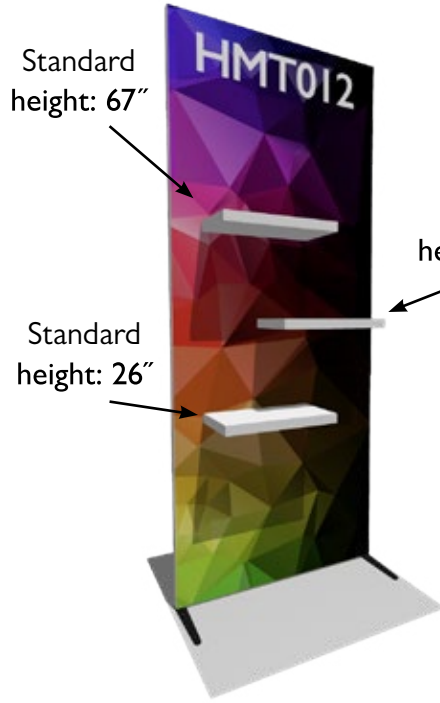

MODULES

HMT011  
3-shelf module M  
+ dye-sub graphic + 2 feet

---

HMT012  
3-shelf module M  
+ dye-sub graphic + 2 feet

---

HMT013  
3-shelf module M  
+ dye-sub graphic + 2 feet

---

HMT014  
3-shelf module M  
+ dye-sub graphic + 2 feet

---

GRAPHICS

Dye-sub graphic

---

Dimensions  
38" x 93"

Dye-sub graphic

---

Dimensions  
38" x 93"

Dye-sub graphic

---

Dimensions  
38" x 93"

Dye-sub graphic

---

Dimensions  
38" x 93"



# 17 Shelving modules

Display

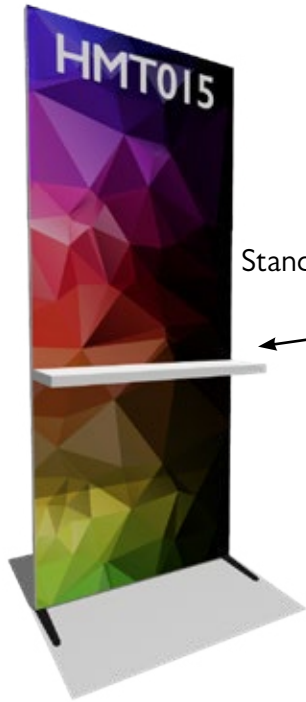

Standard height:  
39.2"

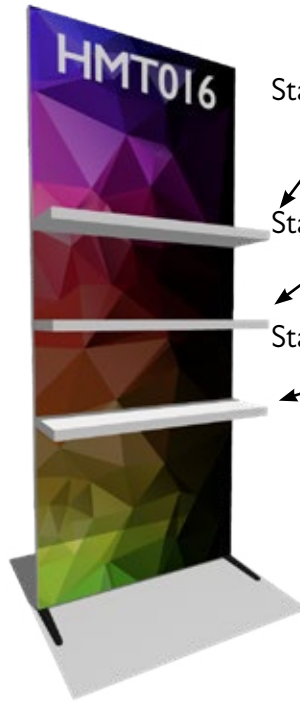

Standard height:  
67"

Standard height:  
46.5"

Standard height:  
46.5"

Standard height:  
26"

Standard height:  
26"



WHITE SHELVES:

Max load: 22 lbs

Dimensions:

L 18.9" x 10.25"

L 37.8" x 10.25"

L 20.4" x 10.25"

Thickness: 1.5"

Standard height of shelves from floor:

26" - 39.2" - 46.5" - 53.8" - 67"

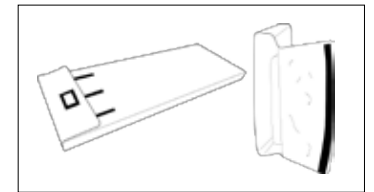

New protective shelf covers included

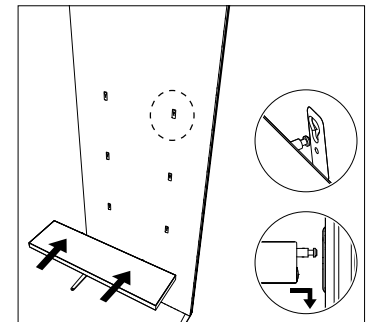

Attaches easily thanks to the universal attachment piece

MODULES

**HMT015**  
1-shelf module L  
+ dye-sub graphic + 2 feet

**HMT016**  
3-shelf module L  
+ dye-sub graphic + 2 feet

**HMT017**  
1-shelf module 520 + 3 brochure holders  
+ dye-sub graphic + 2 feet

GRAPHICS

Dye-sub graphic

Dye-sub graphic

Dye-sub graphic

Dimensions  
38" x 93"

Dimensions  
38" x 93"

Dimensions  
38" x 93"

# 18 Multimedia modules

Spread your message

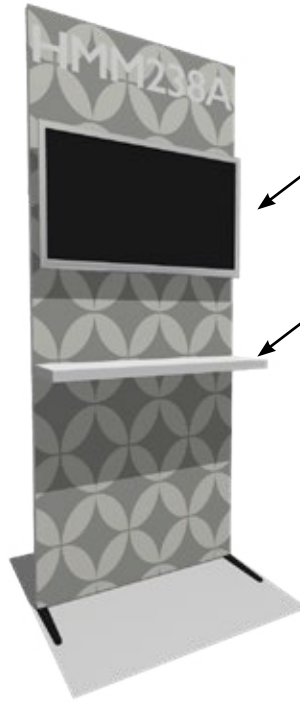

40" TV

Height:  
39.2"



Brochure holder



MODULES

**HMM138A**  
TV\* Monitor Module 38"  
+ dye-sub graphic + 2 feet

**HMM238A**  
TV\* Monitor Module 38"  
+ dye-sub graphic + 1 L shelf + 2 feet

**HMM638**  
TV\* Monitor Module + 3 brochure holders  
+ dye-sub graphic + 1 L shelf + 2 feet

GRAPHICS

Dye-sub graphic

Dye-sub graphic

Dye-sub graphic

Dimensions  
38" x 93"

Dimensions  
38" x 93"

Dimensions  
38" x 93"

# 19 Accessory modules

Create your own accessory module



HCS038  
38" Standard  
frame



HMF002  
Vertical  
accessory bar



CON032  
Universal accessory  
attachment piece



ACS010-01  
Universal  
attachment hook

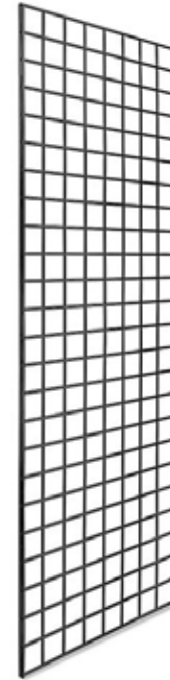

ACS018-01 white  
ACS019-01 black  
Gridwall and connectors



COF086  
Gridwall support  
connector

MODULES

GRAPHICS

Dye-sub graphic

Dimensions

38" x 93"

For each module, you will need 1 frame + the necessary amount of vertical accessory bars + 2 feet

Number of bars	1	2	3	2	2
Recommended for	Brochure holder	TV	Shelves	Wallframe	Gridwall

# 20 Accessory modules



MODULES

**HMG003**  
White accessory gridwall 38" module  
+ dye-sub graphic + 2 feet

---

GRAPHICS

Dye-sub graphic

---

Dimensions  
38" x 93"

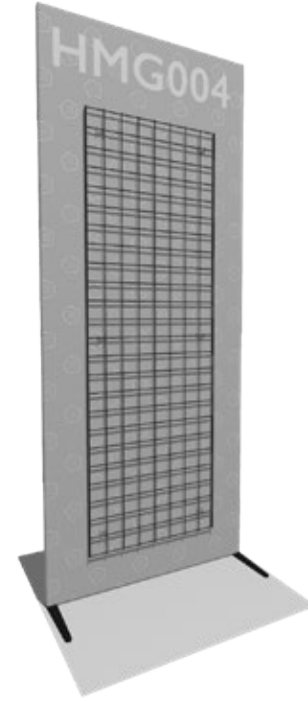

Gridwall size  
2'x6'

Maximum weight  
33 lbs

**HMG004**  
Black accessory gridwall 38" module  
+ dye-sub graphic + 2 feet

---

Dye-sub graphic

---

Dimensions  
38" x 93"

# 21 Accessory modules

Create your own accessory module



ACD017 black  
ACD026 white  
2" straight faceout accessory bar

---



ACD018 black  
ACD027 white  
4", 7 ball waterfall accessory bar

---



ACD019 black  
ACD028 white  
6", 5 hooks waterfall accessory bar

---



ACD020 black  
ACD029 white  
2" hook accessory

---



ACD021 black  
ACD030 white  
4" hook accessory

---



ACD022 black  
ACD031 white  
6" hook accessory

---



ACD023 black  
ACD032 white  
8" hook accessory

---



ACD024 black  
ACD033 white  
10" hook accessory

---



ACD025 black  
ACD034 white  
12" hook accessory

---

GRIDWALL  
ACCESSORIES

# 22 Accessory modules



MODULES

HMFO38-01  
3 brochure holders module  
+ dye-sub graphic + 2 feet

---

HMFO38-02  
2 brochure holders module  
+ dye-sub graphic + 2 feet

---

HMF138  
Wallframe contour 34" x 19" module  
+ dye-sub graphic + 2 feet

---

GRAPHICS

Dye-sub graphic

---

Dimensions  
38" x 93"

Dye-sub graphic

---

Dimensions  
38" x 93"

Dye-sub graphic

---

Dimensions  
38" x 93"

# 23 Canopy modules

Create your own arch module

Choose the front of the arch from among the modules in the brochure (excluding doors), then select the top from among the canopy modules located below.

Design



MODULES

HMV219A  
Canopy module 19"x85"  
+ dye-sub graphic

---

HMV238A  
Canopy module 38"x85"  
+ dye-sub graphic

---

HMV438  
Canopy module with 3 LED lights  
38"x85" + dye-sub graphic

---

HMV219-L2  
Canopy module 19"x85"  
+ dye-sub graphic

---

HMV238-L2  
Canopy lightbox module 38"x85"  
+ dye-sub graphic

---

GRAPHICS

Dye-sub graphic

---

Dye-sub graphic

---

Dye-sub graphic

---

Dye-sub graphic

---

Dye-sub graphic

---

Dimensions  
19" x 85"

Dimensions  
38" x 85"

Dimensions  
38" x 85"

---

Dimensions  
19" x 85"

Dimensions  
38" x 85"

LLD022-01  
3 LED spotlight kit for 38"x85.5"  
canopy\*

\*3 spotlights + 3 panels, 60W electricity supply (LLA061) not included.

# 24 Arch modules

Design

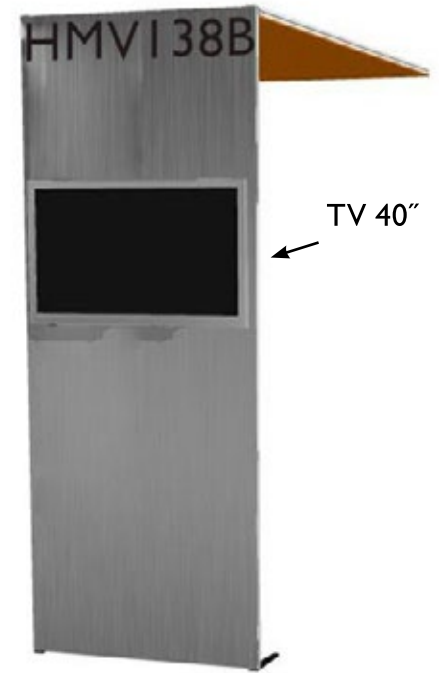

MODULES

HMV019A  
Arch module 19"  
+ dye-sub graphics + 2 feet

---

HMV038A  
Arch module 38"  
+ dye-sub graphics + 2 feet

---

HMVI38B  
Arch module 38" + 40" TV\*  
+ dye-sub graphics + 2 feet

---

GRAPHICS

3 dye-sub graphics

---

3 dye-sub graphics

---

3 dye-sub graphics

---

\*VESA monitor mount (200 x 200 / 400 x 400) with anti-theft security included in price. Recommended TV screen size: 40".  
Weight: 33 lb max. Depth: 3.9" max. Optional TV.



# 25 Lightbox Arch modules

Design



MODULES

HMV038-L2  
Arch module with front\* and canopy lightboxes  
+ dye-sub graphics + 2 feet

---

HMV438-L2  
Arch module with canopy lightbox  
+ dye-sub graphics + 2 feet

---

HMV538-L2  
Arch module with front lightbox\*  
+ dye-sub graphics + 2 feet

---

GRAPHICS

3 dye-sub graphics

---

3 dye-sub graphics

---

3 dye-sub graphics

---

\* Module can be rotated so that the rear side is backlit

Power supply bracket not included.

# 26 Header modules

Be seen



Raised  
by  
4.75"



Raised  
by  
4.75"



MODULES

HMH438  
Header module\* 38"x38"  
+ dye-sub graphics

HMH438-E  
Header module\* 38"x38" with spacers  
+ dye-sub graphics

HMH638  
Header module\* 38"x76"  
+ dye-sub graphics

HMH638-E  
Header module\* 38"x76" with spacers  
+ dye-sub graphics

GRAPHICS

4 dye-sub graphics

4 dye-sub graphics

6 dye-sub graphics

6 dye-sub graphics

Total height  
131"

Total height  
136"

Total height  
131"

Total height  
136"

Storage modules are required for these options

\*Only for 38" x 38" and 38" x 76" storage modules

# 27 Signage modules

Be seen

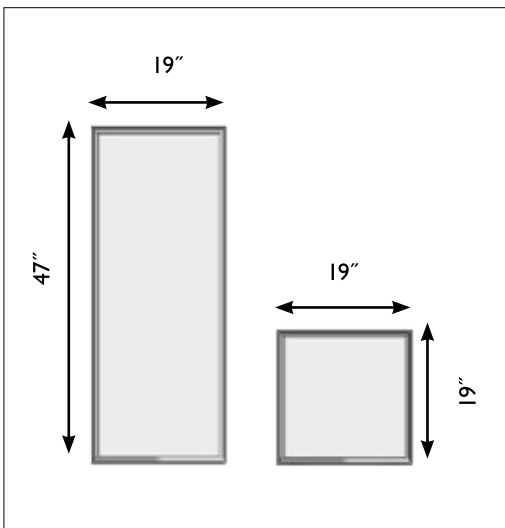
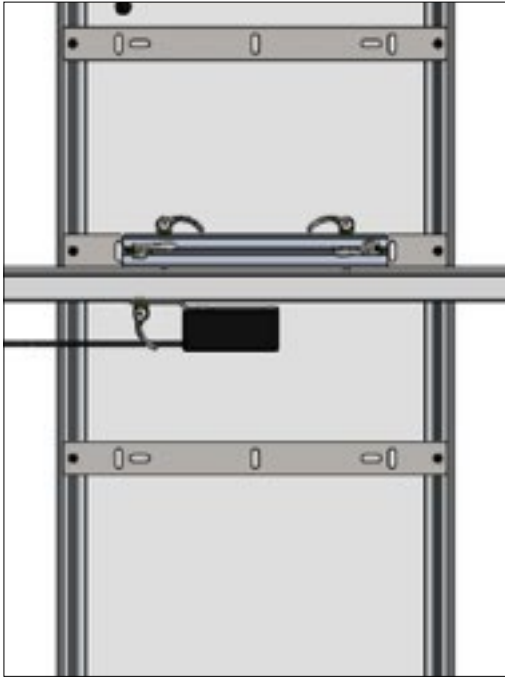

- Think outside the frame!
- 2 dimensions: 19" x 19" or 19" x 47"
- 3 pre-defined positions: low, middle, high
- Lightbox or non-lightbox
- Ships pre-assembled in the top case

# 28 Signage modules

Be seen

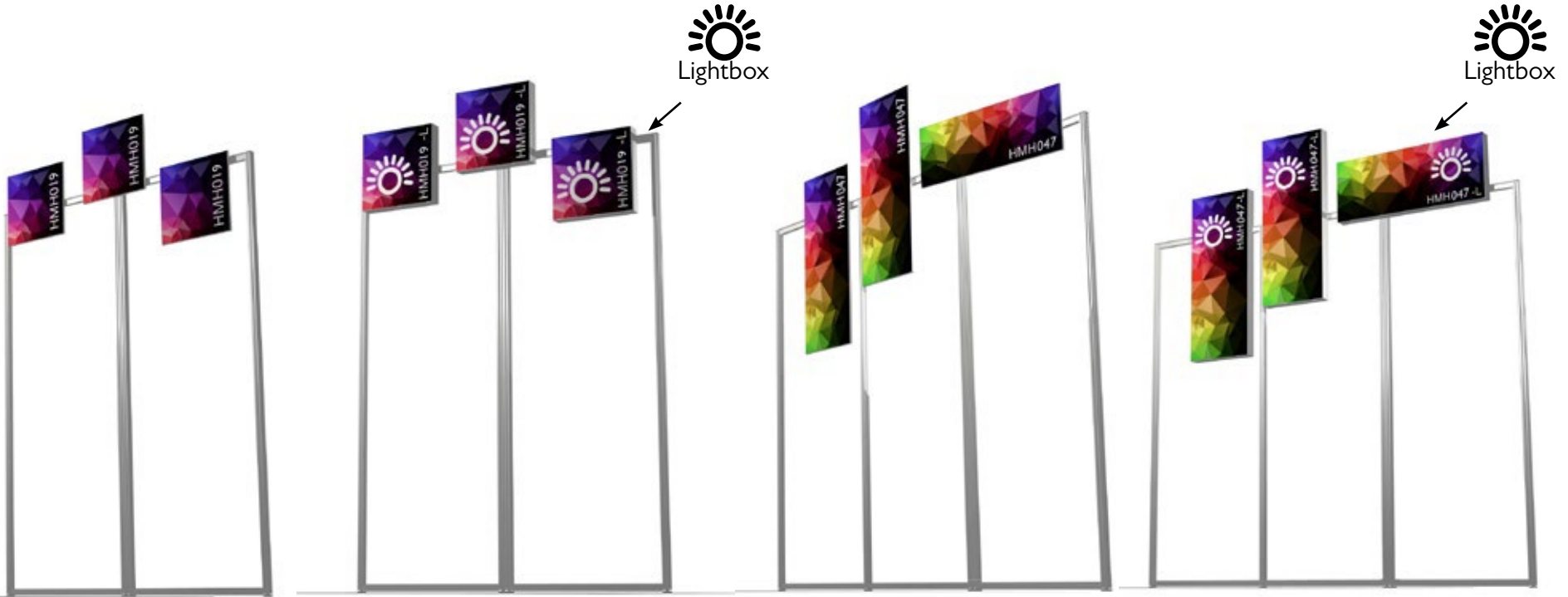

MODULES

HMH019  
Signage module S  
+ dye-sub graphic

---

HMH019-L  
Lightbox signage module S  
+ dye-sub graphic

---

HMH047  
Signage module M  
+ dye-sub graphic

---

HMH047-L  
Lightbox signage module M  
+ dye-sub graphic

---

GRAPHICS

Dye-sub graphic

---

Graphic dimensions  
19"x19"

Dye-sub graphic

---

Graphic dimensions  
19"x19"

Dye-sub graphic

---

Graphic dimensions  
19"x47"

Dye-sub graphic

---

Graphic dimensions  
19"x47"

# 29 USB counters and consoles

Greet

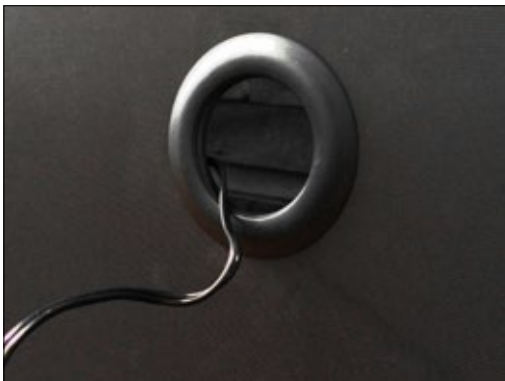

- New USB hub option
- Integrates directly into the countertop
- Equipped with 4 USB ports and a hole to feed through other cables
- Available as an add-on on counter and console modules

# 30 Counter modules

Greet

Total height (countertop included) : 39.5"

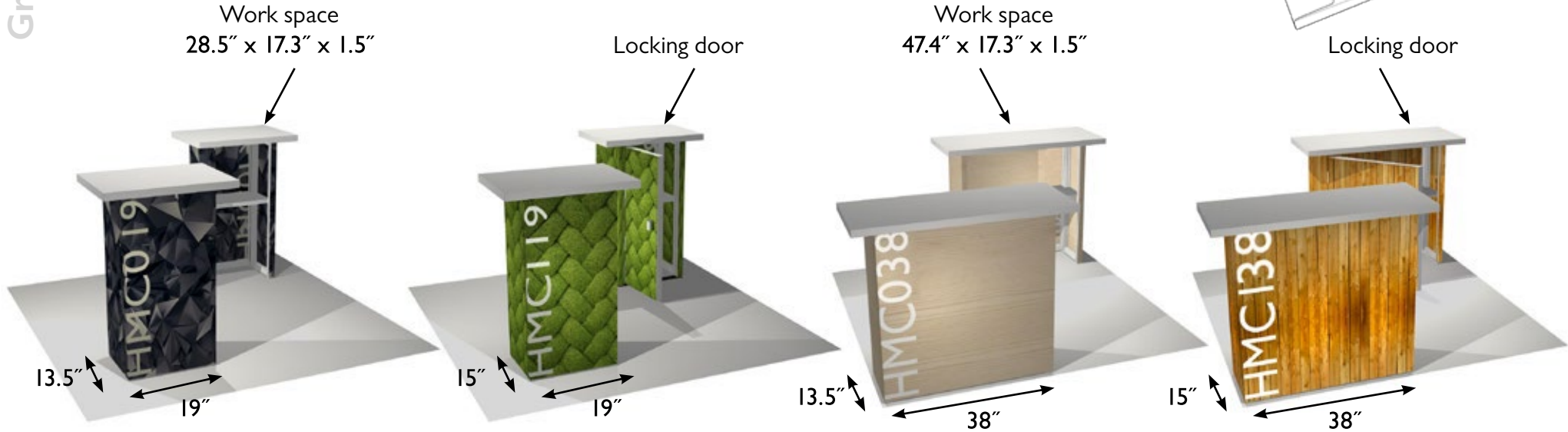

MODULES

**HMC019**  
Small counter module  
(28.5" x 17.3" x 39.5")  
+ dye-sub graphics

**HMC119**  
Small counter module with door  
(28.5" x 17.3" x 39.5")  
+ dye-sub graphics

**HMC038**  
Medium counter module  
(47.4" x 17.3" x 39.5")  
+ dye-sub graphics

**HMC138**  
Medium counter module  
(47.4" x 17.3" x 39.5")  
+ dye-sub graphics

GRAPHICS

3 dye-sub graphics

**HMC019-USB**   
Option with USB hub

6 dye-sub graphics

**HMC119-USB**   
Option with USB hub

3 dye-sub graphics

**HMC038-USB**   
Option with USB hub

6 dye-sub graphics

**HMC138-USB**   
Option with USB hub

# 31 Connecting modules

Greet

Total height (countertop included) : 39.5"

Connect two HMC038  
counters to create a  
94.5" x 17.3" work space



Additional work space  
17.3" x 17.3"

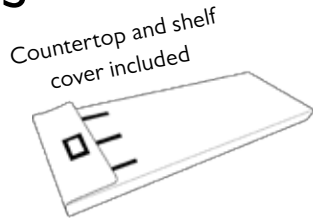

Countertop and shelf  
cover included

MODULES

HMC038-L  
Connecting module to connect  
2 counters (straight) + dye-sub graphic

HMC038-L  
Connecting module to connect 2  
counters (angle) + dye-sub graphics

GRAPHICS

1 dye-sub graphic

3 dye-sub graphics

# Lightbox counter modules

Total height (countertop included) : 39.5"

Work space  
47.4" x 17.3" x 1.5"

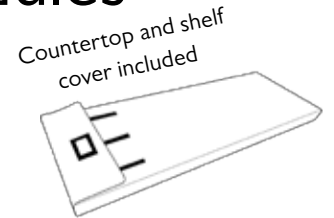
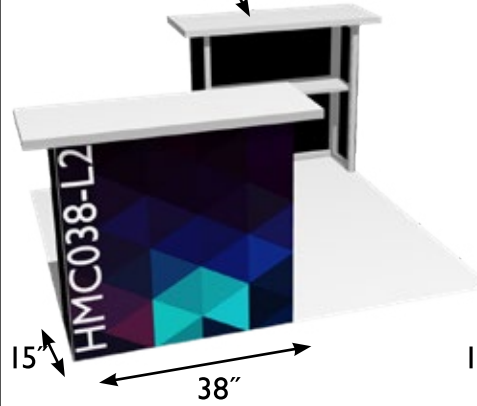

Countertop and shelf  
cover included

Locking door

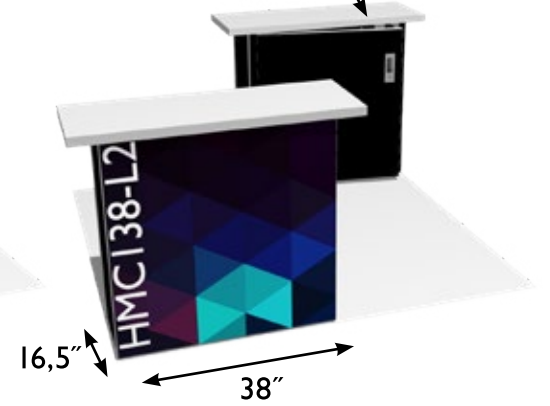

HMC038-L2  
M Counter module with front  
lightbox + dye-sub graphics

HMC038-L2  
M counter module with door  
and front lightbox + dye-sub graphics

3 dye-sub graphics

6 dye-sub graphics

HMC038-L2-USB   
Option with USB hub

HMC038-L2-USB   
Option with USB hub

\*The HMC004 module is not compatible with the lightbox counters.

Lightbox ships with standard connectors.  
Power supply bracket not included.

# 32 Console modules

Console height (incl. countertop): 39.5"

Negotiate

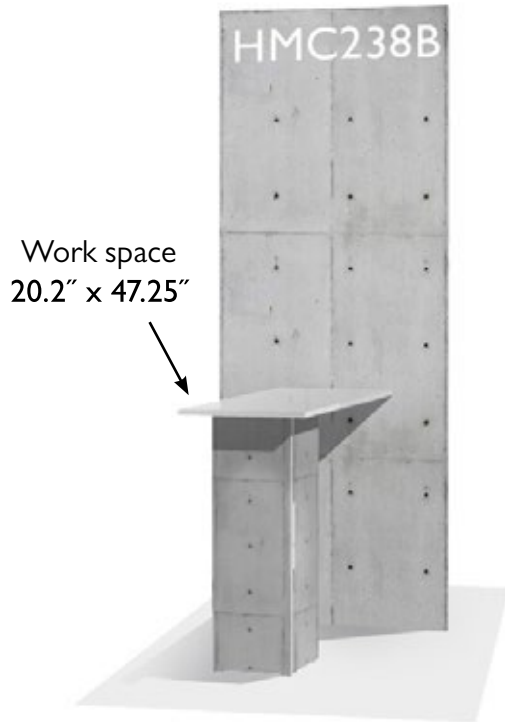

**HMC238B**  
Console module  
+ dye-sub graphics

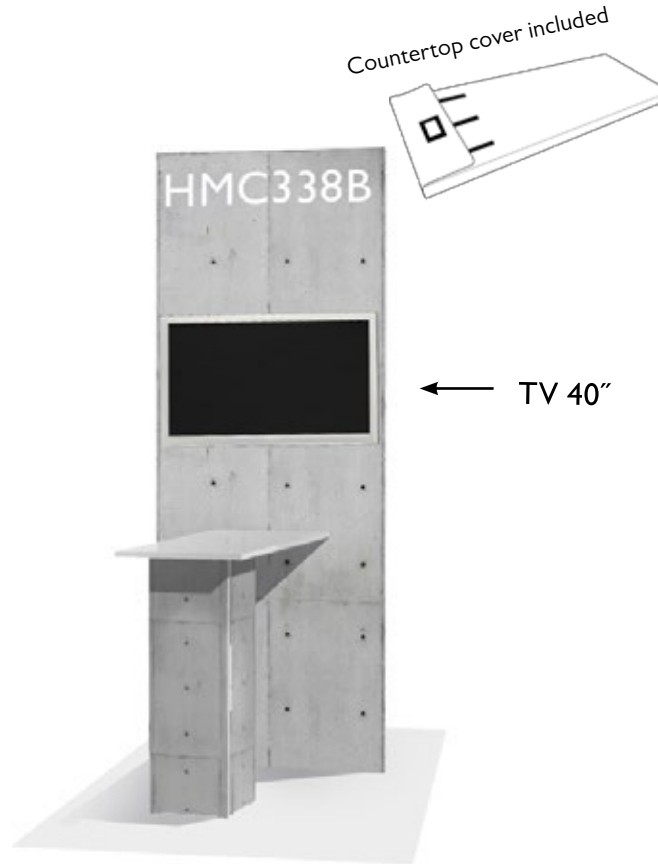

**HMC338B**  
Console module with 40" TV\*  
+ dye-sub graphics

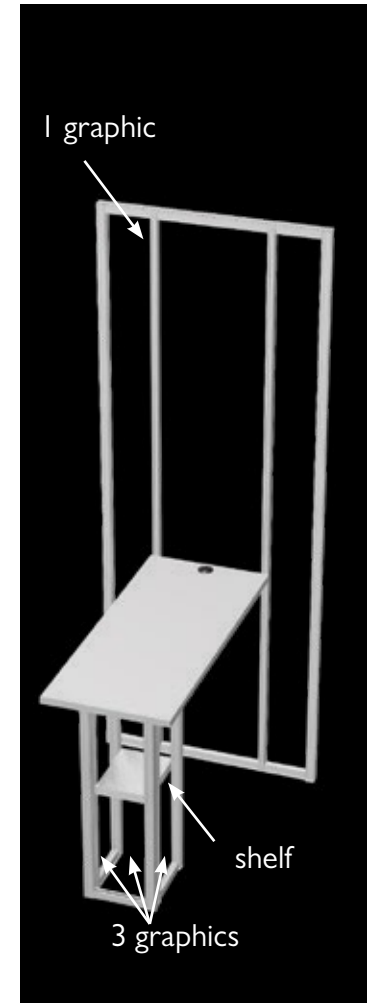

MODULES

GRAPHICS

4 dye-sub graphics

HMC238B-USB   
Option with USB hub

4 dye-sub graphics

HMC338B-USB   
Option with USB hub



Grommet for cable management

\*VESA monitor mount (200 x 200 / 400 x 400) with anti-theft security included in price.  
Recommended TV screen size: 40". Weight: 33 lb max. Depth: 3.9" max. Optional TV.





3%  
REALTY  
AGENTS OF CHANGE

Full suite of REALTOR® services  
Full exposure on the MLS® system  
No fine print, just 3% commission

- Modular exhibits, ideal for 10'x10', 10'x20', 10'x30' and 20'x20' spaces
- Packaged in a wheeled crate, with frames and graphics preassembled
- May be set up with or without professional assistance

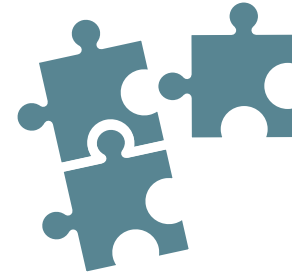

modular

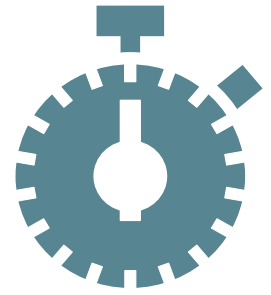

rental

# modular exhibits

# 34 100% modular: 13 modules, 4 shows, 4 configurations, 4 locations

Reconfigure your h-line exhibit to suit your event, using the same pack of modules each time

10'x10'

Montréal



10'x10'

Chicago



10'x20'

Toronto



10'x20'

Las Vegas



# 35 100% modular: 13 modules for an unlimited number of configurations!

## 13 module pack

- 1 HMS038 standard module
- 1 HMS038-L2 standard lightbox module
- 2 HMS019 standard modules
- 2 HMSI38 standard half-height modules
- 1 HMF038-01 brochure-holder module
- 1 HMC238B console module
- 1 HMT011 shelving module
- 1 HMC119 counter module
- 1 HMRI38 storage module
- 1 HMMH047-L lightbox signage module
- 1 HMMVI38B arch module 38" + 40" TV
- 1 SOS kit
- 2 Signature LED 20W spotlight
- 1 H3 crate





### h10-03

Contact us to request a quote for a purchase or rental

Suggested transport solution  
1 h-line H3 crate

10'x10'

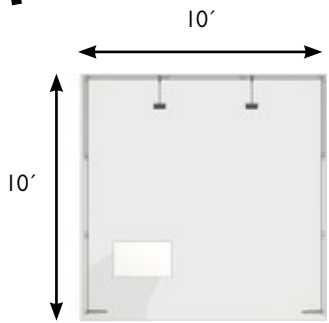

height 93"



HMC119 counter



LED light



Simply add 3 more standard 38" modules to turn it into a 10'x20' exhibit



## h10-06

Contact us to request a quote for a purchase or rental

Suggested transport solution  
1 h-line H3 crate

# 10'x10'

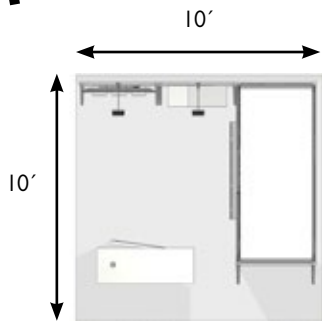

height 93"



HMC038 counter with USB hub



Add new modules and accessories to create a customized 10'x20' exhibit



## h10-08

Contact us to request a quote for a purchase or renta

Suggested transport solution  
1 h-line H3 crate

# 10'x10'

10'

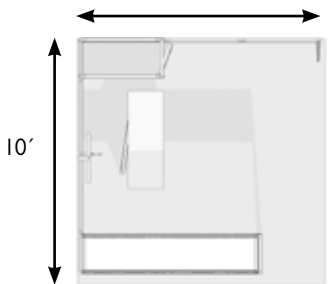

10'

height 93"



Create a backlit arch in width of 19"



Add 2 standard modules and a TV module to turn into a 10'x20' exhibit



### h10-01

Contact us to request a quote for a purchase or renta

-----

Suggested transport solution  
 3 flightcases for LED panels  
 + 1 48" x 96" palet

# 10'x10'

10'

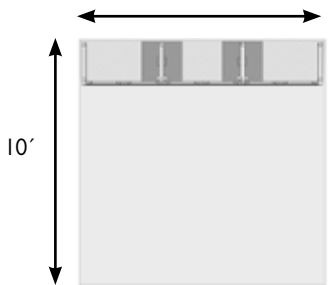

height 93"

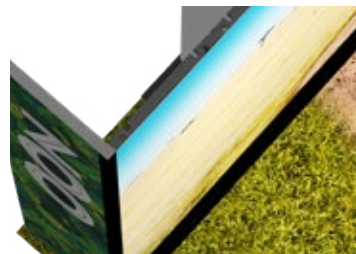

The thinnest panel: 1.57" (40 mm)

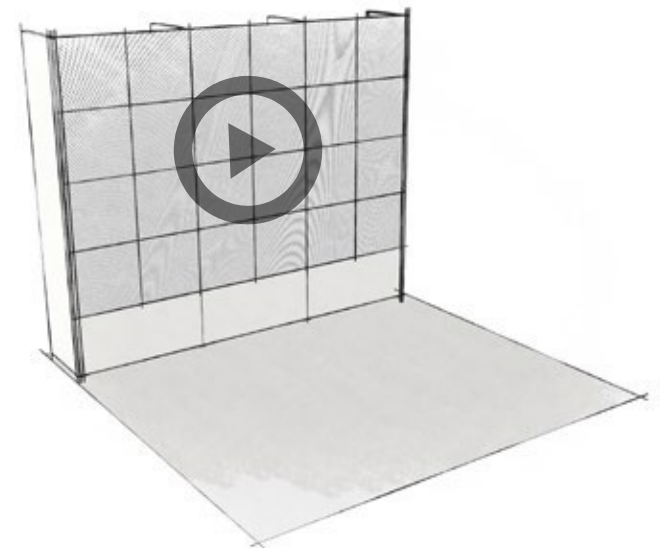

Broadcast your message on panoLED video walls



## h10-02

Contact us to request a quote for a purchase or renta

Suggested transport solution  
 2 flightcases for LED panels  
 + 1 h-line H3 crate

10'x10'

10'

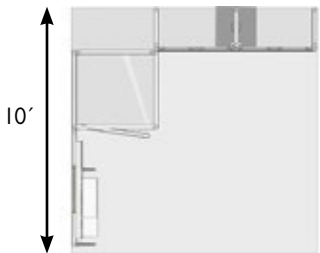

10'

height 93"



Use compatible frames to align your video wall height to the exhibit height

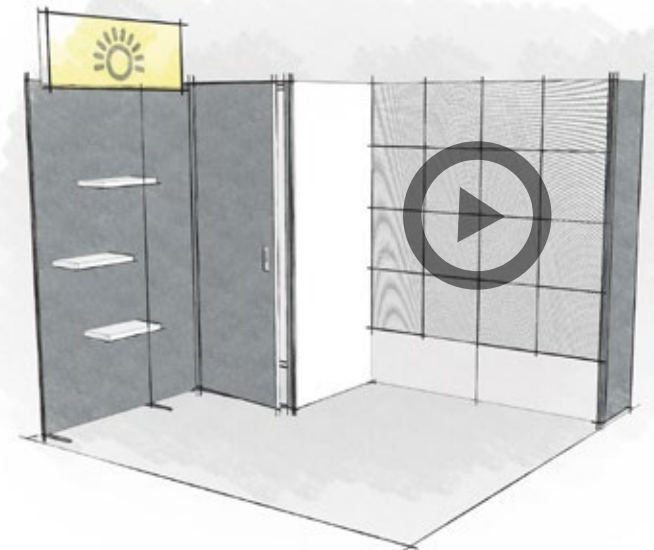



Display your items on shelves



## h10-07

Contact us to request a quote for a purchase or renta

Suggested transport solution  
| h-line H3 crate

# 10'x10'

10'

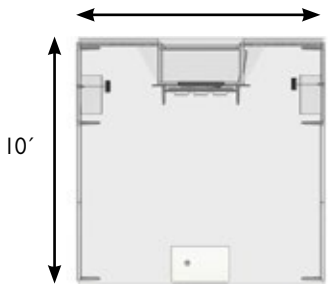

height 93"



3 brochure holders module + TV  
(HMM638)

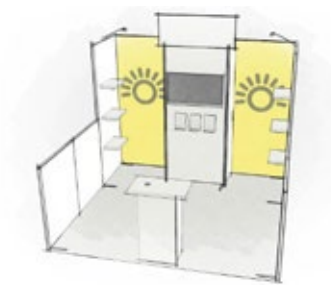

Add 2 38" lightbox modules and 2 standard 19" modules to create a 10'x20' exhibit

Combine different heights to increase impact



## h20-27

Contact us to request a quote for a purchase or renta

Suggested transport solution  
1 h-line H3 crate

10'x15'

15'

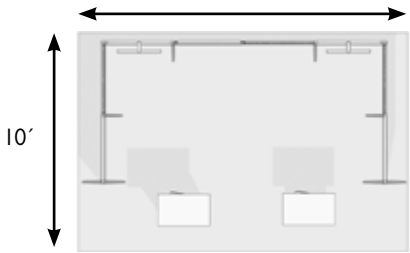

hauteur 95"



Backlit and nonbacklit modules

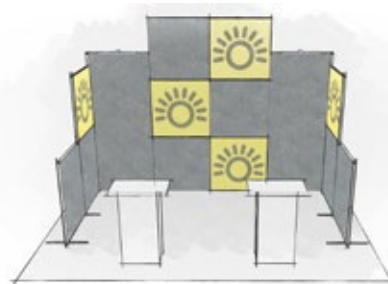

Add 2 lightbox modules and 2 standard modules to turn into a 10'x20' exhibit

Signature spotlight for powerful, homogeneous lighting



## h20-12

Contact us to request a quote for a purchase or renta

Suggested transport solution  
1 h-line H3 crate

# 10'x20'

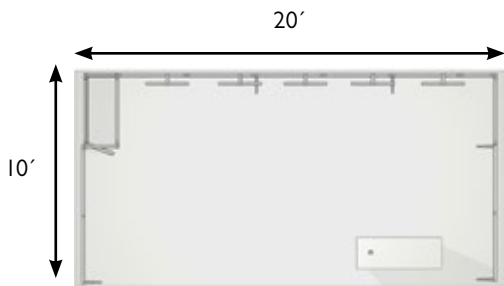

height 93"



HMC038 counter

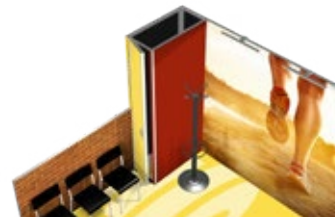

HMR119 storage module



Remove modules and adapt to a smaller area: 10'x10'

Increase visibility with a header



## h20-28

Contact us to request a quote for a purchase or rental

Suggested transport solution  
1 h-line H3 crate

10'x20'

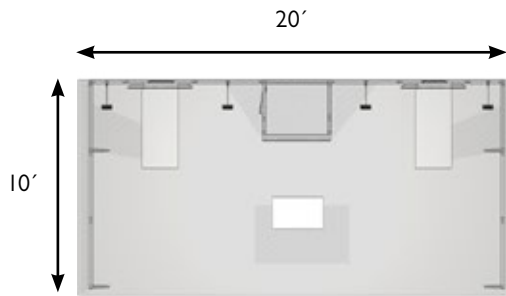

height 93"  
header height: 38"



Interior shelf in each console

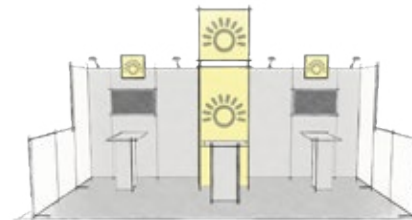

Remove modules and adapt to a smaller area: 10'x10'



Increase the impact of your communication with lightbox modules

Concentrateur USB

## h2o-24

Contact us to request a quote for a purchase or renta

Suggested transport solution  
2 h-line H3 crates

10'x20'

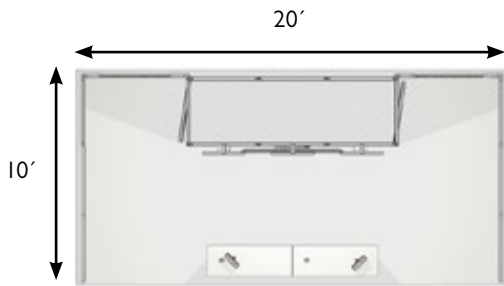

height 93"  
header height: 38"



Brochure holders and TV



2 HMC038-USB counters connected with HMC003



Add header modules to transform your exhibit into a central 20'x20' island

Vary your messages with wall.frame



## h20-26

Contact us to request a quote for a purchase or renta

Suggested transport solution  
I h-line H3 crate

# 10'x20'

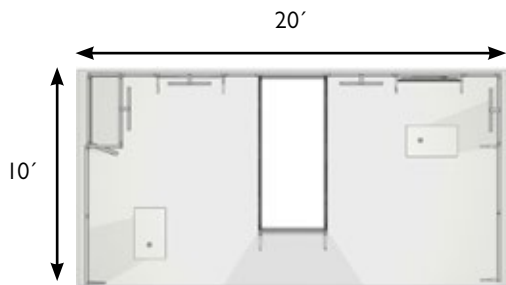

height 93"



Storage module HMRI19



Increase the size of your exhibit to 10'x30':  
add 1 storage module, 1 arch and 1 counter

### h2o-11

Contact us to request a quote for a purchase or renta

Suggested transport solution  
2 flightcases for LED panels  
+ 1 h-line H3 crate

Even more impact with the panoLED video wall



10'x20'

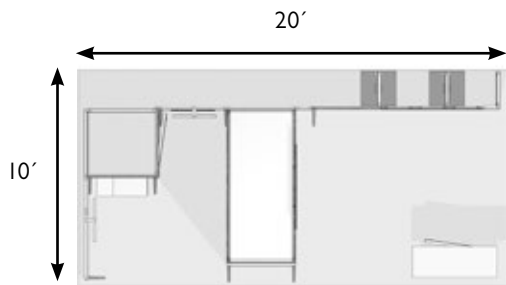

height 93"  
header height: 38"



Create an optical illusion effect by combining still graphics and animated videos

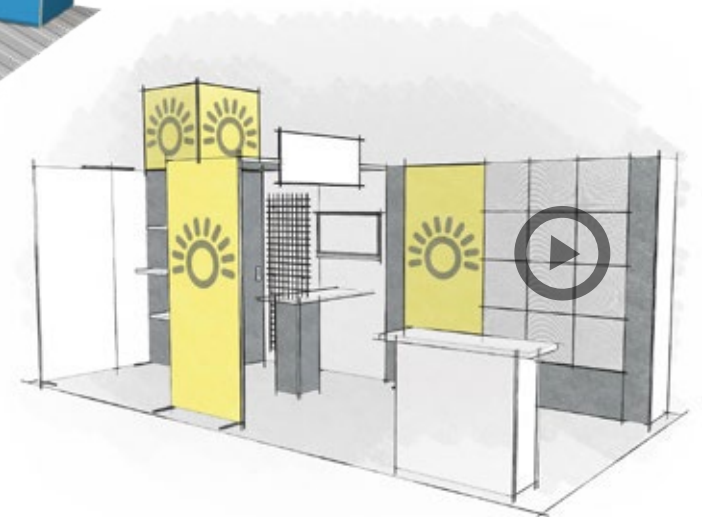

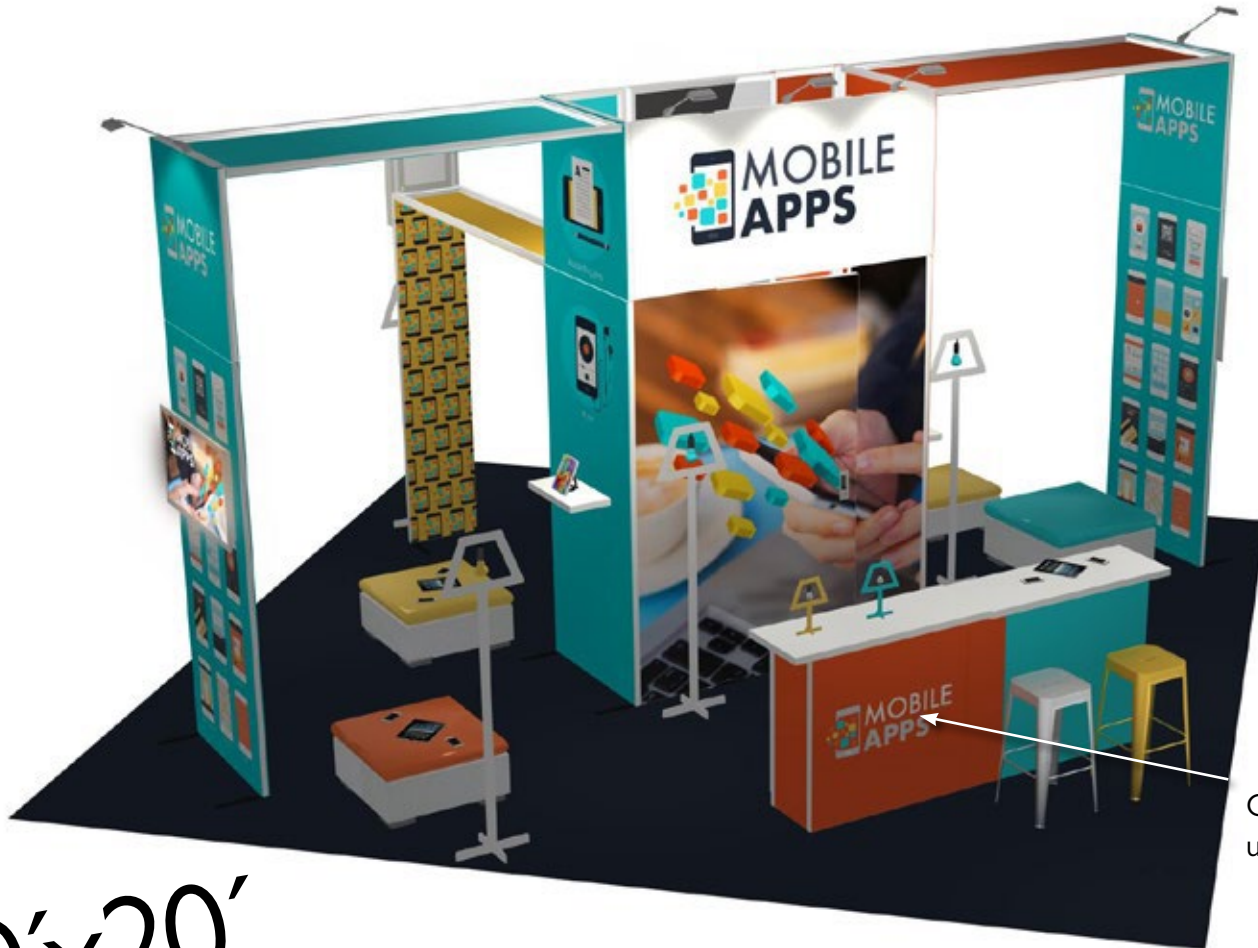

## h20-29

Contact us to request a quote for a purchase or rental

Suggested transport solution  
2 h-line H3 crates

Connect two counters using the connection module

20'x20'

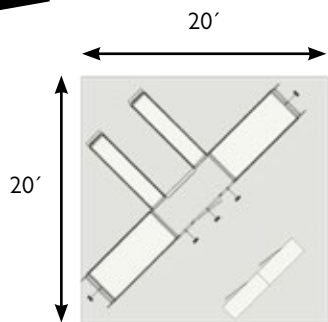

height 131"



Lightbox signs to display your logo

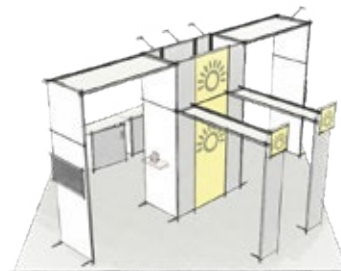

Add 2 standard 38" modules, 1 19" module and 1 9" module to change the layout of your exhibit to 10'x20'



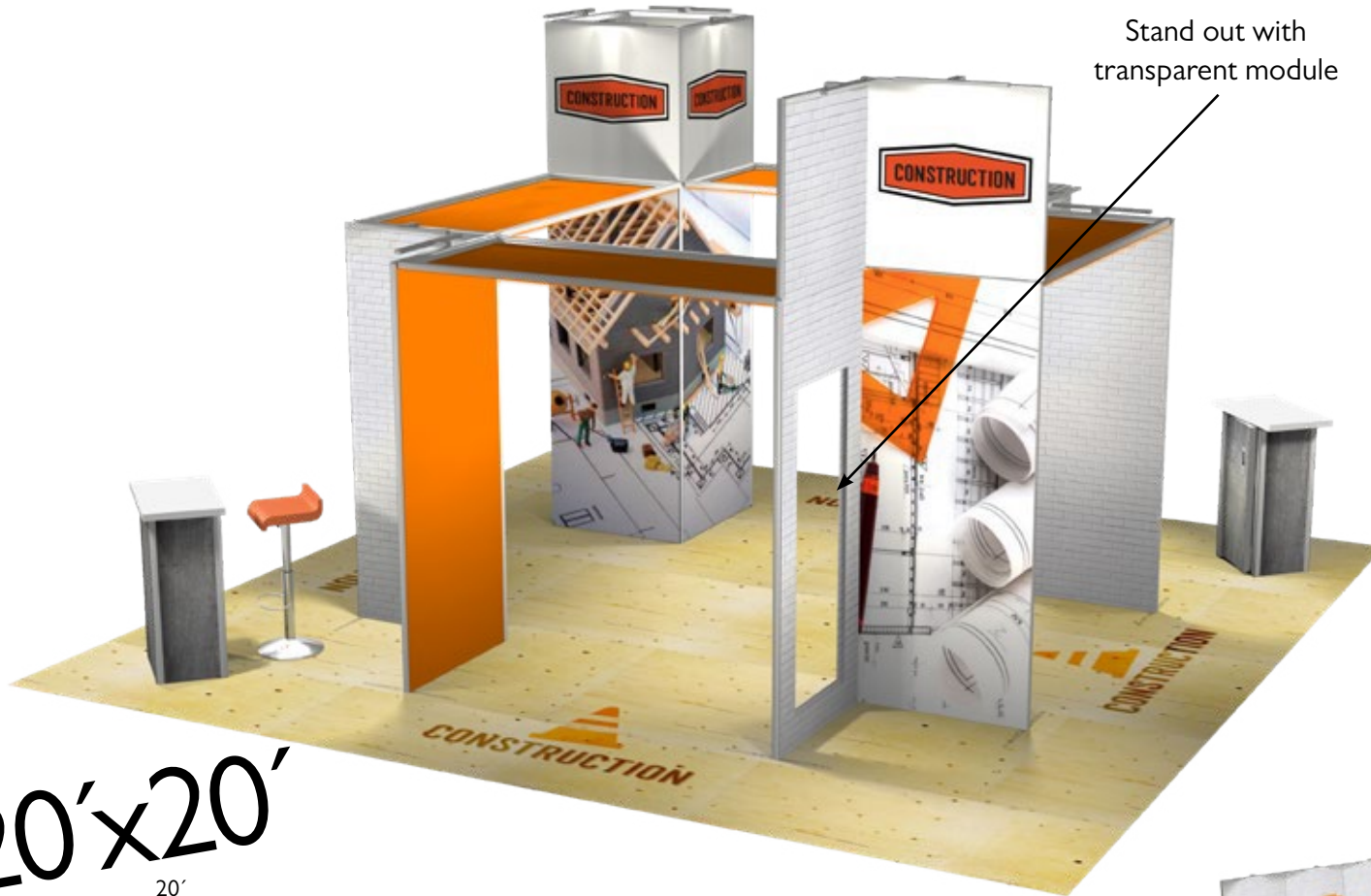

## h20-10

Contact us to request a quote for a purchase or renta

Suggested transport solution  
2 h-line H3 crates

20'x20'

20'

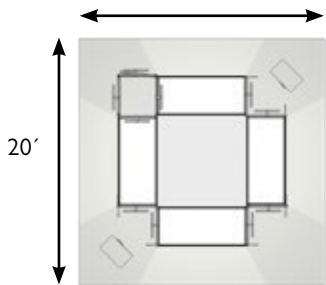

height 131"



Arch module with lightbox  
velum HMV438-L

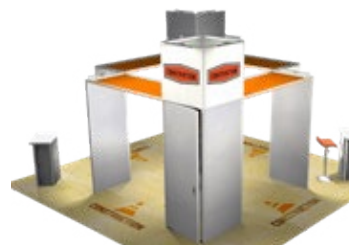

HMR038 storage module



Create a very different design  
using the same area and more functionalities

Showcase your products with the helix.200 display case



## h30-02

Contact us to request a quote for a purchase or renta

Suggested transport solution  
2 h-line H3 crates

# 20'x30'

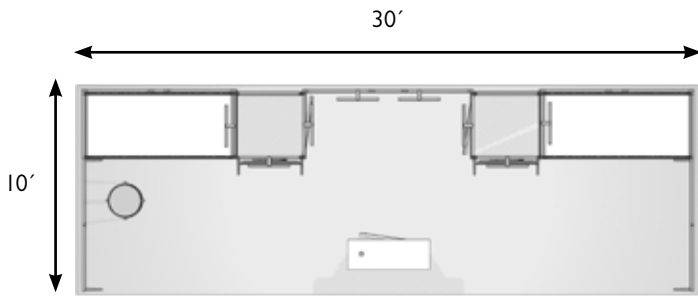
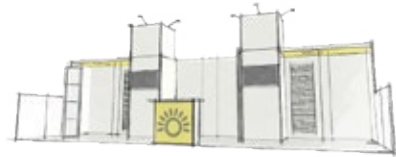

height 93"  
header height: 38"



Grid module to attach various accessories



Remove modules and adapt your exhibit to a smaller area: 10'x20'

# 51 Pre-fit your modules!

Accessory module  
compatible

Accessoirize

TV40L (-LOC)  
TV Samsung LED 3D 40"  
+ remote control



ACS011-01  
TV mount



ACS012-01  
Tablette holder



panoLED  
LED panel



ACT028-12  
18.9" x 10.25" S shelf  
+ 2 supports + cover



ACT028-13  
20.4" x 10.25" M shelf  
+ 2 supports + cover



ACT028-11  
37.8" x 10.25" L shelf  
+ 2 supports + cover



HCW001  
wall.frame 34"x19"



COF071-01  
Brochure holder



# 52 Pre-fit your modules!

Accessoirize

COL037  
h-line connector



COL032-01  
Lightbox connector



COF065-01  
Power supply bracket for lightbox



HAL002  
Electricity kit (two 10' extension cords + one 3-outlet power strip)



HAL004  
Electricity kit with attachment piece (two 3m extension cords + one 3-outlet power strip + attachment piece for power supply)



LED4-US-S3  
LED light with bag



LLF020  
Transformer  
+ 6 extension cords



# 53 Pre-fit your modules!

Accessoirize



LED-SIGNATURE-US  
Signature LED 20W spotlight with  
transformer and bag

---

With its sleek, contemporary lines, it integrates flawlessly into your booth designs.

It lights the panel powerfully and uniformly thanks to its elongated 23.62" form, as well as its specially designed optics.

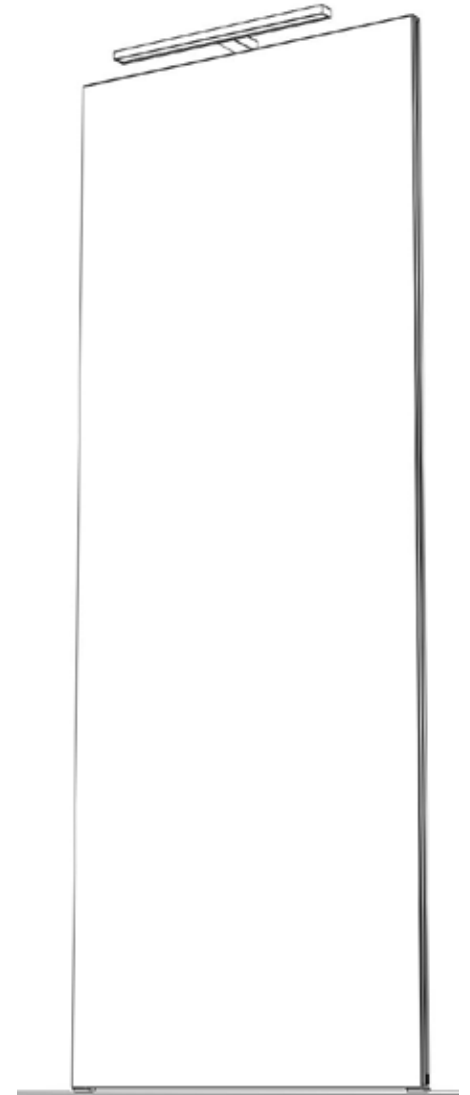

# 54 Pre-fit your modules!

Accessoirize

ACP022  
Stabilizing foot



ACP023  
Double-sided stabilizing foot



ALP005-04  
Aluminum profile cover (height 93")



ALP005-07  
Aluminum profile cover (height 46.5")



LLS012  
Cord protector



HAR001  
Storage kit for 38" storage modules (free-standing shelves, coat rack + 4 hangers and 2 trash bins)



HAR002  
Closet kit for 19" closet modules (rod and 4 hangers + 1 trash bin)

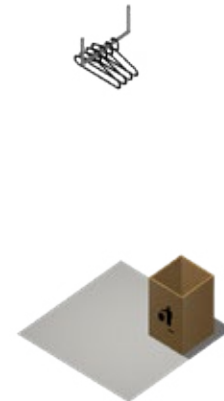

# 55 Travel solution

Storage crate



Track system

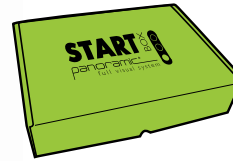









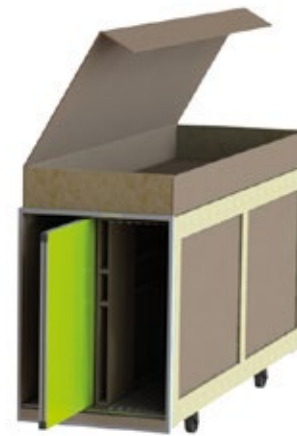









## H3 Crate

External dimensions:  
L 34" x P 97" x H 60"

Weight:  
400 lbs

Can contain (14) 38" frames, (1) 19" frame and (1) 9.5" frame.  
For use with liftgate or ramp. Includes a top case.



CONNECTOR			
ACCESSORIES			
			
			
			
			
STORAGE FURNISHINGS			

# 56 Travel solution

Storage crate



## H5 Crate

External dimensions:  
30.25" x 56.25"H x 96.5"

Weight:  
245 lbs

Can contain 12 frames. For use without liftgate or ramp (case to be loaded wheels up in your vehicle to ensure perfect stability during transport) Includes a top case.



Partitionable crate



# 57 Exhibit database

# Even more exhibits at: panoramic-design.com

Find your exhibit in just a few clicks



panoramic™ full visual system

panoramic design search

SEARCH (28 products)

Remove filters

Categories

- 10'x10' (5)
- 10'x20' (18)
- 10'x30' (3)
- 20'x20' (2)
- counters (0)
- modules (0)
- > 20'x20' (0)

Booth Layout

- Corner (2)
- Counter (0)
- Inline (13)
- Island (11)
- Kiosk (2)
- Peninsula (0)

Price

5019 - \$ 18382

Reset this group

- Storage (24)
- Tower / Header / High signage (0)
- Shelves / Column (12)
- Semi private conf. area (16)
- Counter (4)
- Reception / Ask for info (0)

There are 28 products.

Sort by Product Name: A to Z

<b>101</b>	<b>102</b>	<b>103</b>	<b>104</b>
Length : 20' Width : 10' Booth size : 10'x20'	Length : 20' Width : 10' Booth size : 10'x20'	Length : 20' Width : 20' Booth size : 20'x20'	Length : 10' Width : 10' Booth size : 10'x10'
<b>\$13,410.00</b>	<b>\$6,887.00</b>	<b>\$17,968.00</b>	<b>\$10,495.00</b>
<a href="#">See the product</a>	<a href="#">See the product</a>	<a href="#">See the product</a>	<a href="#">See the product</a>
<b>106</b>	<b>107</b>	<b>108</b>	<b>109</b>
Length : 20' Width : 10'	Length : 10' Width : 10'	Length : 20' Width : 20'	Length : 20' Width : 10'

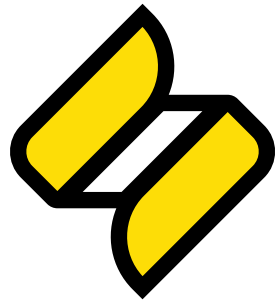

**signature.**  
GRAPHICS

**DESIGN.  
CREATE.  
INSTALL.**

**519.601.6297**

317 Adelaide St. S, London ON. N5Z 3L3

[www.signaturegraphics.ca](http://www.signaturegraphics.ca)   